

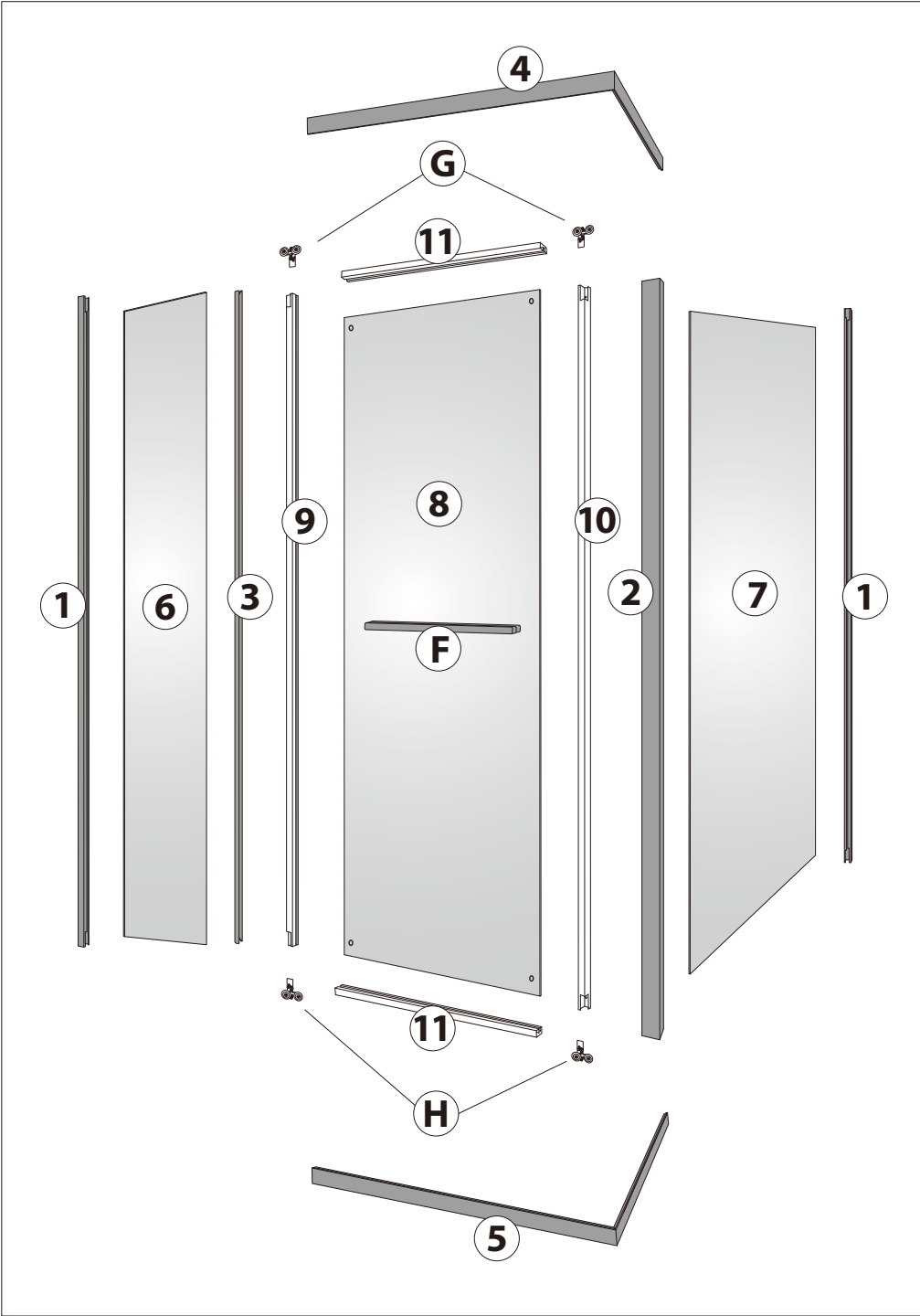

INSTALLATION MANUAL

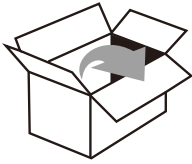





A

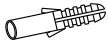

X6

B



X6

C



X1

D



X4

E

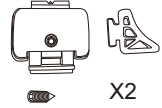

X2

F



X1

G

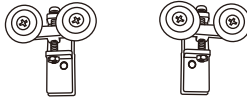

X2

H

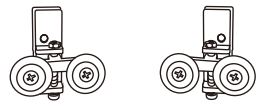

X2

J



X4

K



X4

L



X4

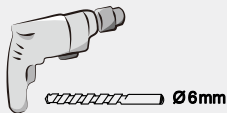
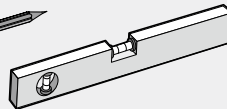
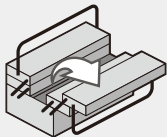

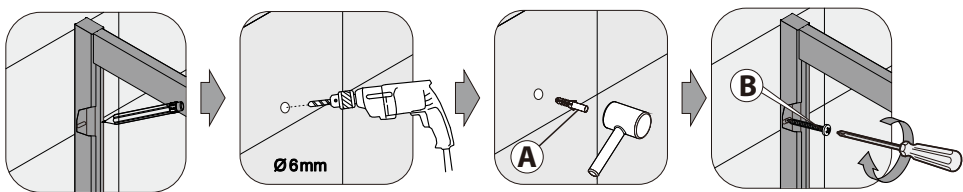
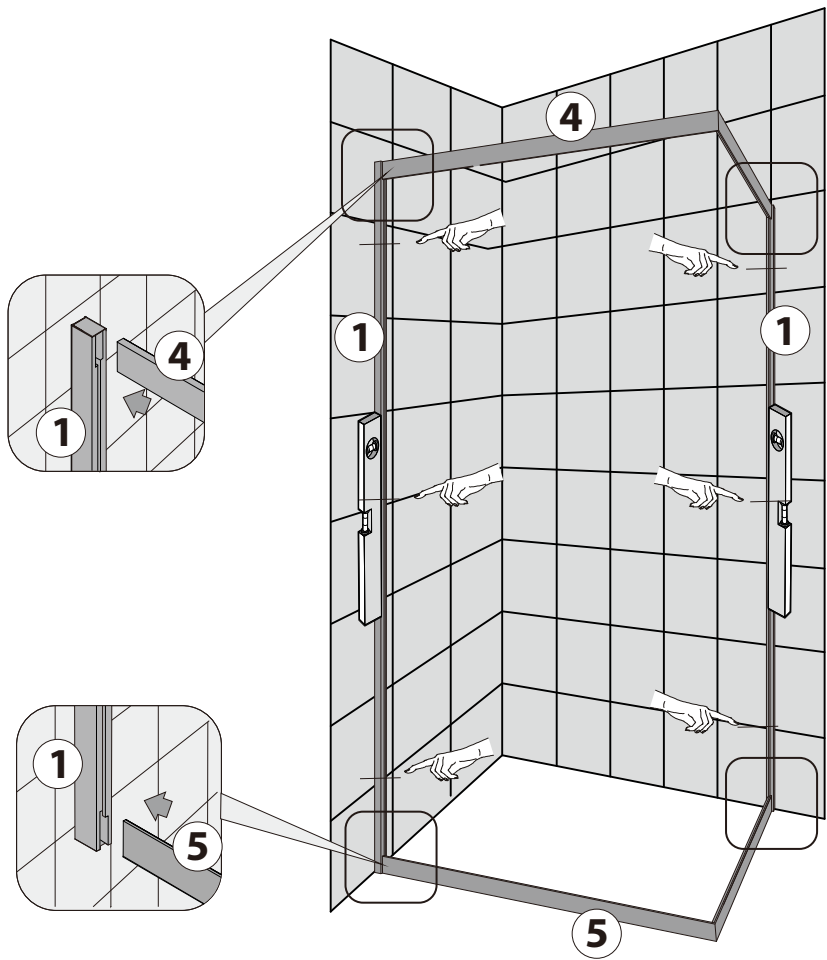
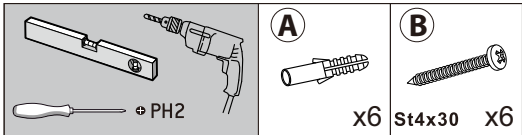

PH2



C

