

## 7 Završni radovi

Postaviti magnetne (G) i F-brtve (H) kako je prikazano na skicama.

Ako je potrebno dodatno nivelisati vrata, to se čini odvijanjem ili dotezanjem vijaka na gornjim točkicama.

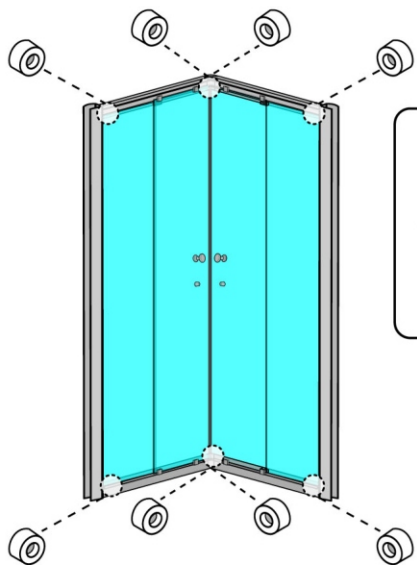
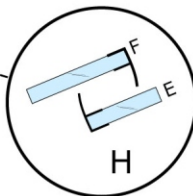
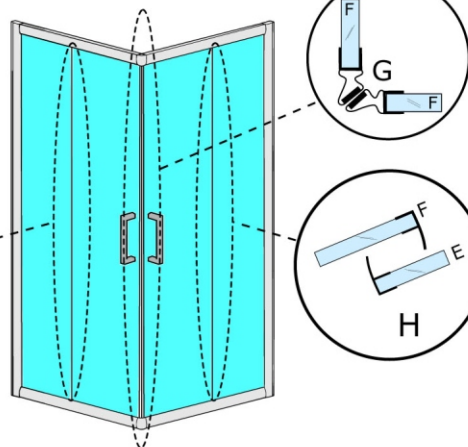
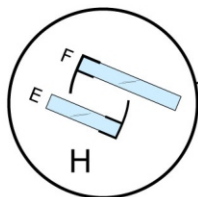

Nakon što su vrata nivelisana, na optimalne pozicije unutar vodilica vijcima 4,2x9,5 zavrnuti gumene graničnike (O) koji će zaustavljati vrata prilikom otvaranja ili zatvaranja.



**Poslije montaže kabine sačekati 24 h prije prve upotrebe.**



24 h



## Uputstvo za montažu NOIR

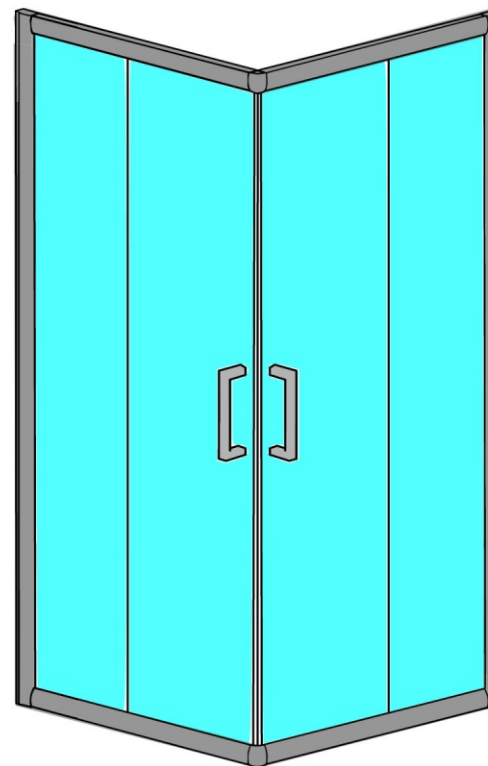

### MODELI

80x80	H190
90x75	H190
90x80	H190
90x90	H190
100x80	H190
100x90	H190
100x100	H190
110x80	H190
110x90	H190

Iako je kvalitet materijala za kabine vrhunske kvalitete, može biti oštećen kako mehanički, tako i upotrebom određenih hemikalija (aceton i sl.). Takođe je moguće narušiti sjaj profila upotrebom abrazivnih sredstava.

U procesu ugradnje kabine preporučujemo da tuš, ako se na isti vrši montaža, zaštitite kartonom od mogućih oštećenja pri montaži kabine.

Proizvođač ne odgovara za štetu ili povredu osoba nastalih nepravilnom ugradnjom.



# 1 Sastavni dijelovi - šema

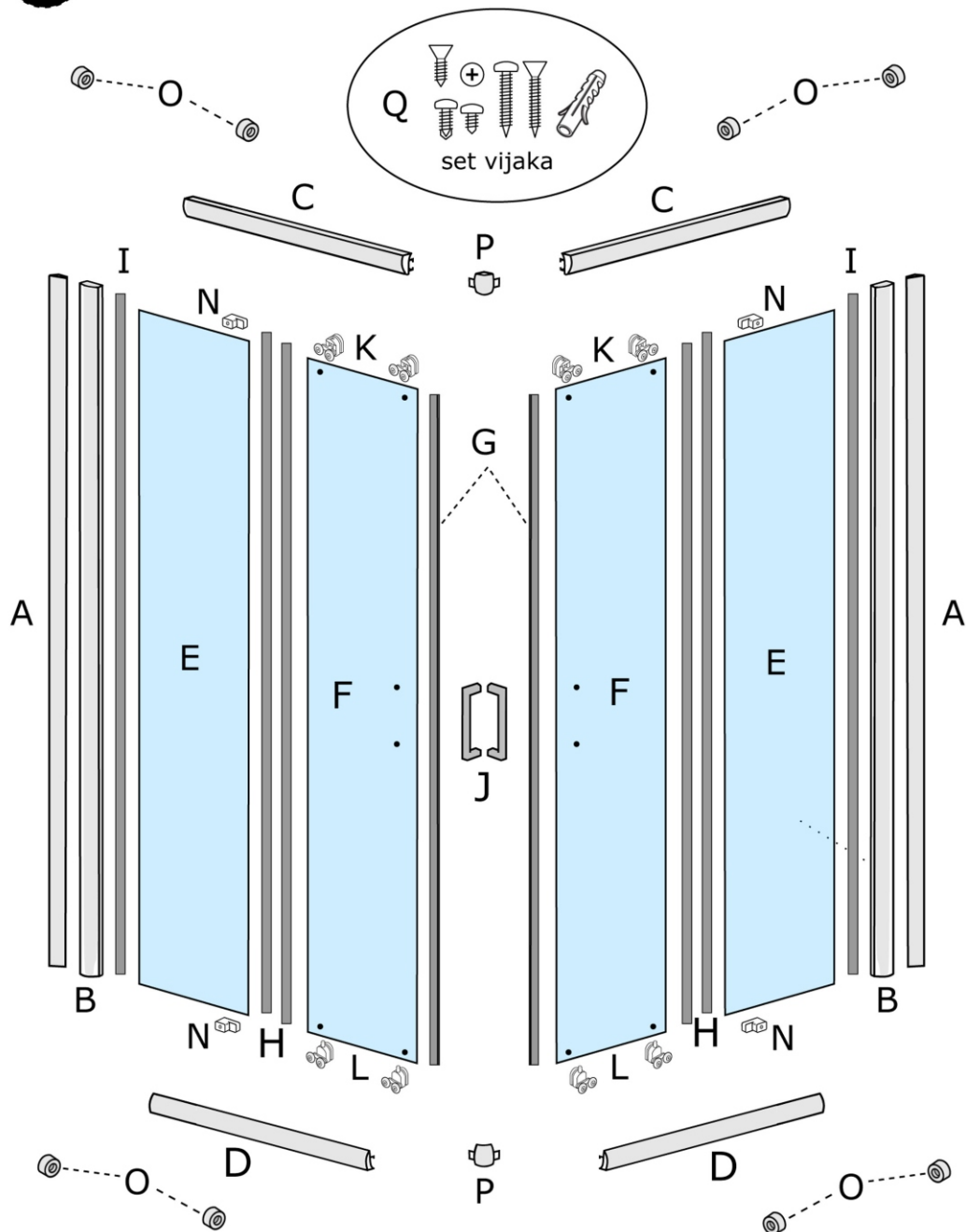

# 6 Završni radovi

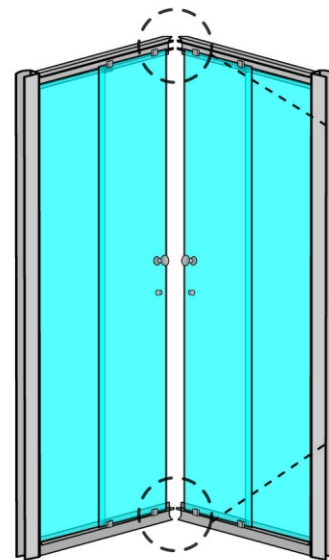

Ubaciti ugaone veznike P u vodilice (C i D), te ih pričvrstiti samoreznim vijcima 4,2x13.

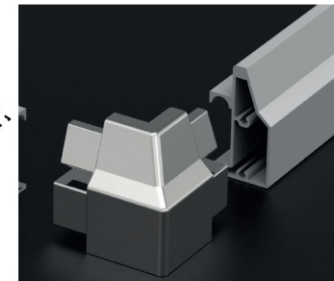

Nakon što je okvir spojen i ubačen u zidne profile, pričvrstiti ih jedne za druge samoreznim vijcima 4,2x13.

Nanijeti tanki nanos silikona na mjesto gdje fiksno staklo naliježe na donju vodilicu.  
Nakon toga, silikonirati spojeve okvira sa keramikom/tuš kadom.

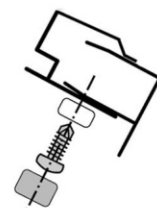
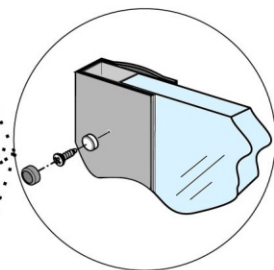
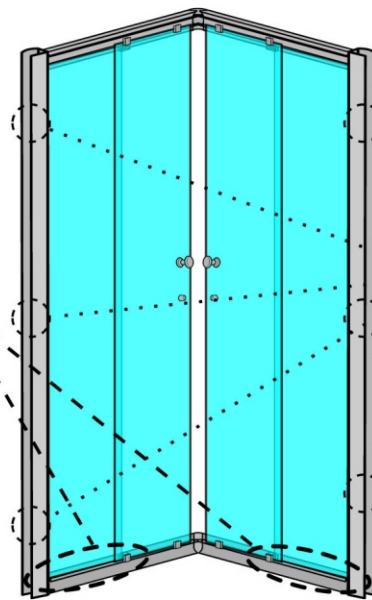

## 5 Montaža vrata

Postavljanje rukohvata (J), te gornjih (K) i donjih (L) točkića na vrata (F).



Donji točkići imaju "dugmić" čijim se pritiskom točkići spuštaju prilikom ubacivanja u donju vodilicu.

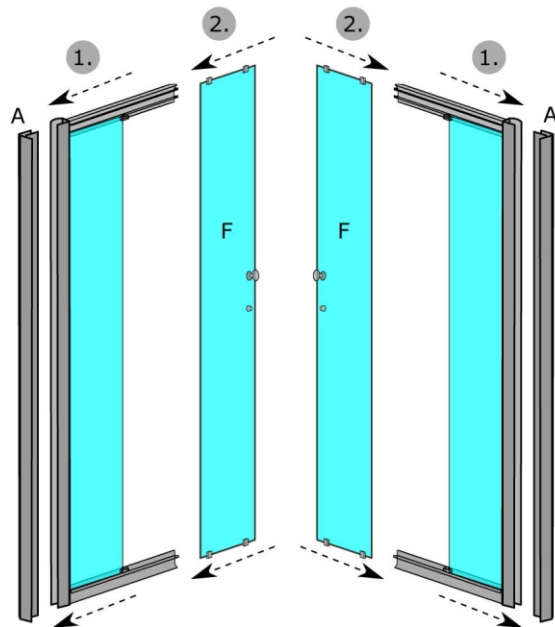
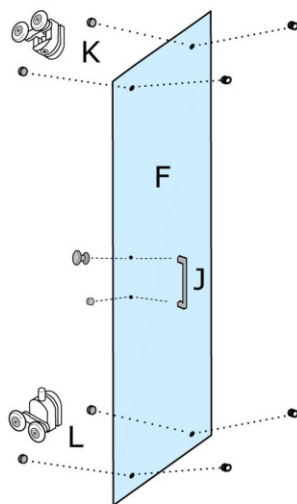

1.

Umetanje okvira sa fiksnim staklima u već pričvršćene zidne profile (A).

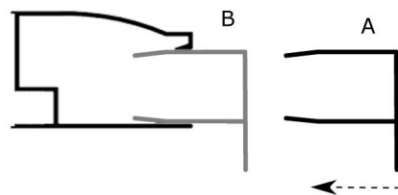

2.

Umetanje vrata u vodilice.

## 2 Sastavni dijelovi - lista

A

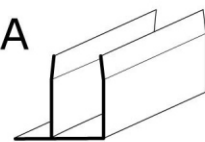

Profil zidni  
x2

B

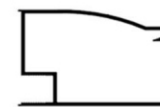

Profil za staklo  
x2

C



Gornja-zatvorena vodilica  
x2

D



Donja-otvorena vodilica  
x2

E

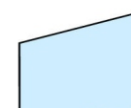

Staklo fiksno  
x2

F

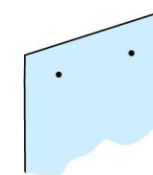

Vrata  
(6 rupa)  
x2

G

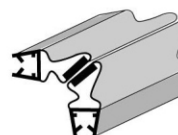

Brtve-magnetne

H

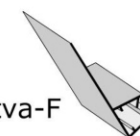

Brtva-F  
x4

I

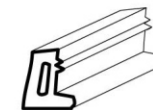

Brtva za fiksno staklo  
x2

J



Rukohvat  
x2

K

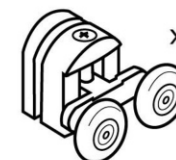

Točkić gornji  
x4

L

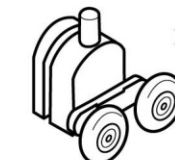

Točkić donji  
x4

N

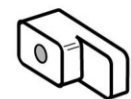

Držać fiksnog stakla  
x4

O



Gumeni stoper  
x8

P

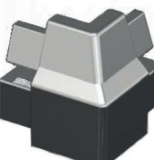

Ugaoni veznik  
x2

### 3 Nivelacija i učvršćivanje zidnih profila

Libelom izvršiti nivelaciju zidnih profila.

Označite mjesto za bušenje na zidu.

Obratiti pažnju na to da se dimenzija kabine broji od krajnje ivice zidnog profila.

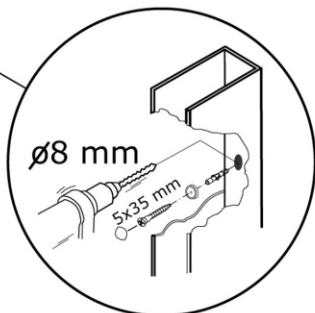
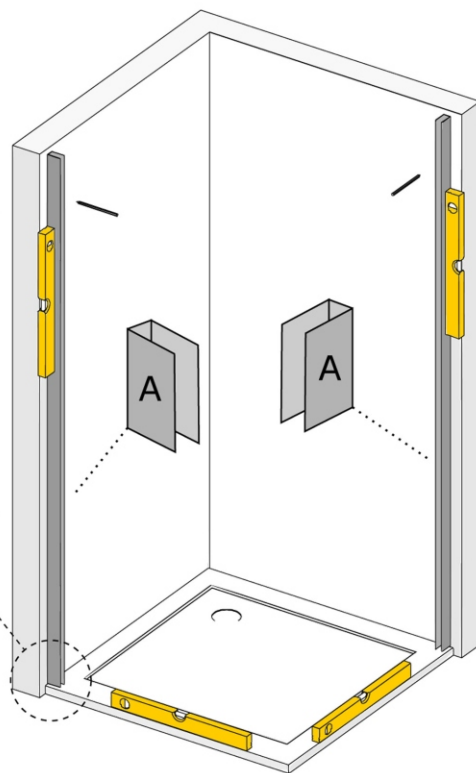
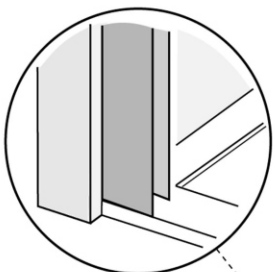

Odmaknite profil, izbušite rupe i postavite tiplove.

Nanesite silikon na zadnju stranu profila, postavite profil na zid i pričvrstite ga vijcima  $5 \times 35 \text{ mm}$ .

3

www.aquamax.ba

### 4 Montaža fiksnih stakala i vodilica

Spajanje gornjih vodilica (C) sa vertikalnim profilom (B) pomoću vijaka  $3,5 \times 25/38$ . Ukrasna rozeta (M) se postavlja na samom spoju.

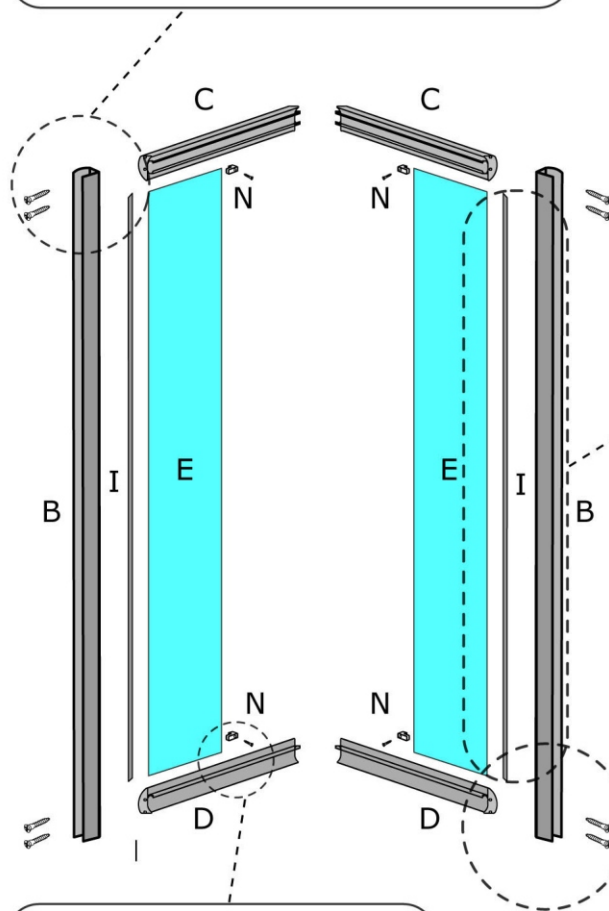

Fiksiranje držača fiksnih stakala (N) vijcima  $4,2 \times 13$  upuštene glave.

Spajanje donjih vodilica (D) sa vertikalnim profilom (B) pomoću vijaka  $3,5 \times 25/38$ .

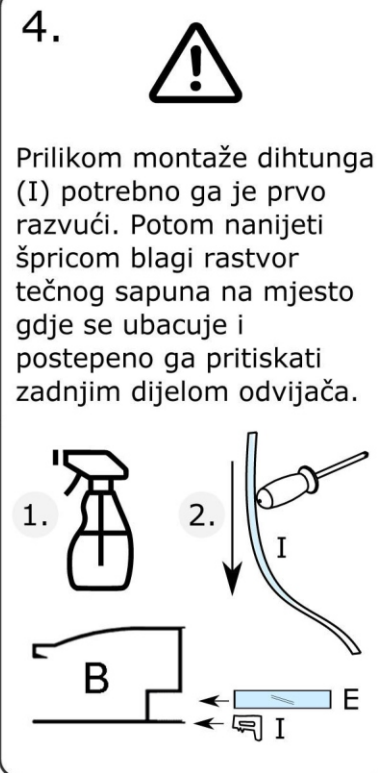

www.aquamax.ba

4